

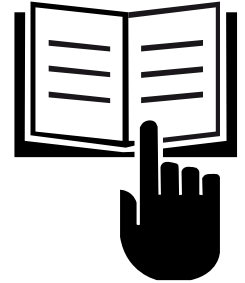

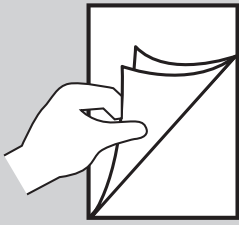



- GB** Universal Digital Pressure Tester
- FR** Testeur de pression digital universel
- DE** Universeller digitaler Druckprüfer
- SP** Probador de presión digital universal
- IT** Tester di pressione digitale universale
- PT** Verificador Universal de Pressão Digital
- NL** Universele digitale druktester



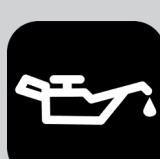

I		page 1
II	 Gasoline	page 3
III	 Diesel	page 4
IV	 Gasoline Diesel	page 6
V		page 7

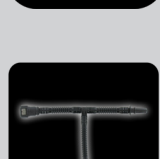
VI		page 8
VII		page 9
VIII		page 10
IX		page 11
X		page 12
XI		page 13





1

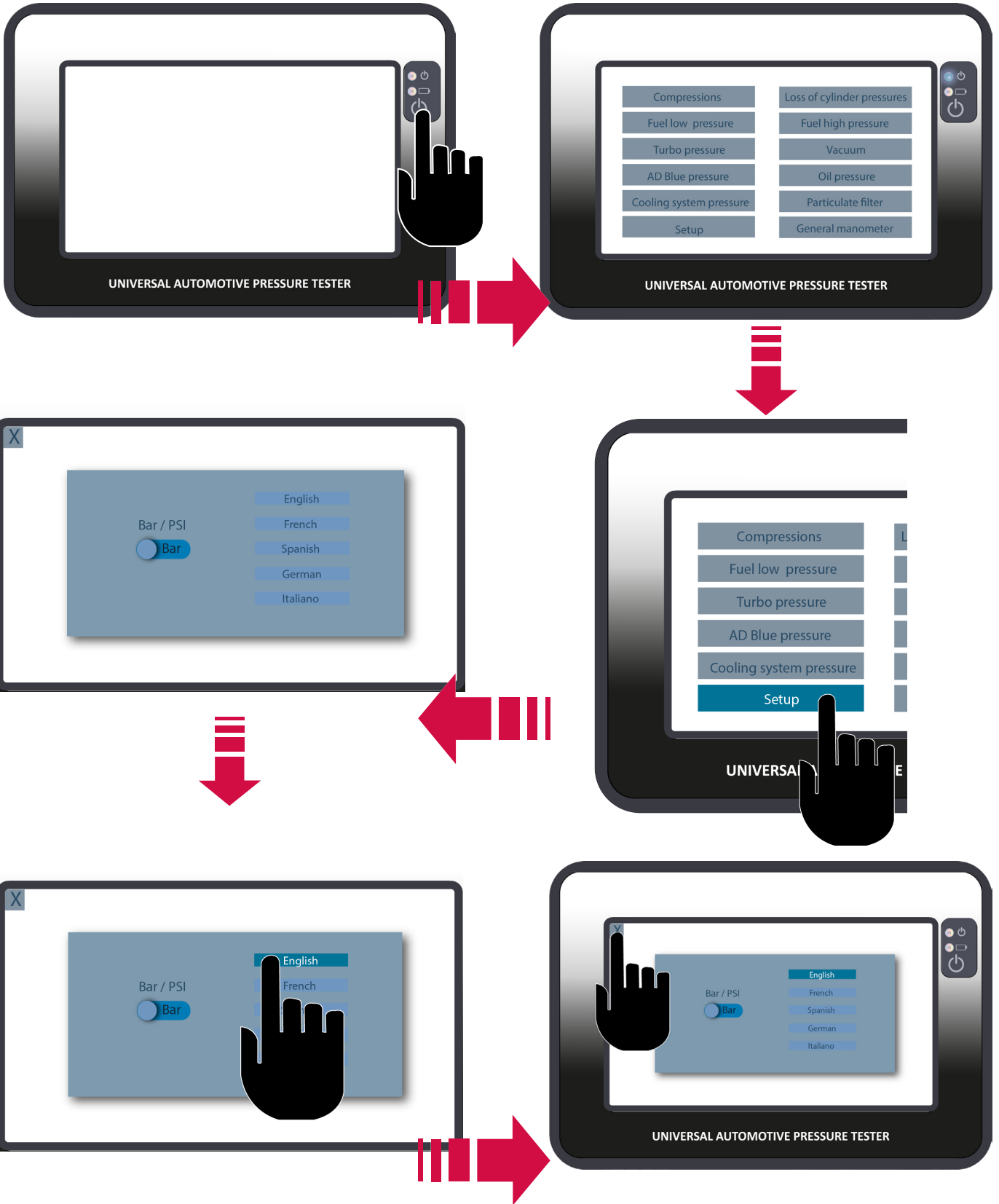

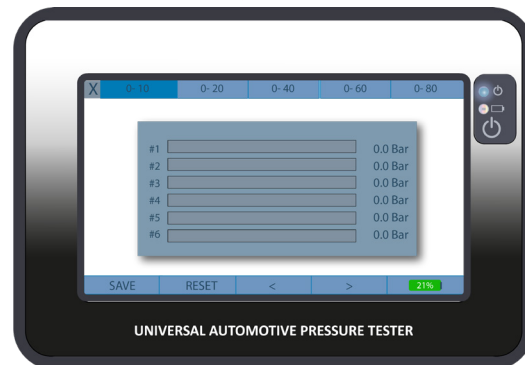
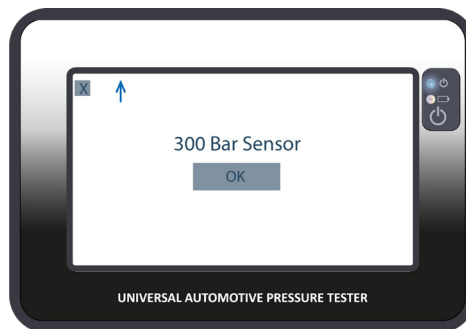
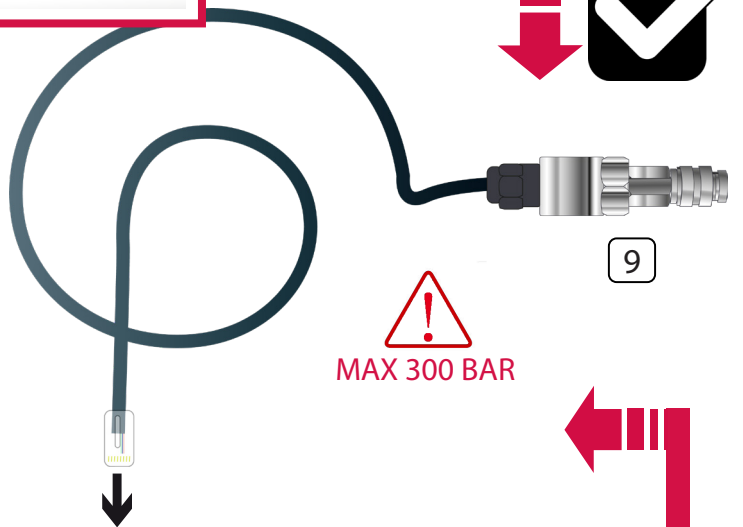
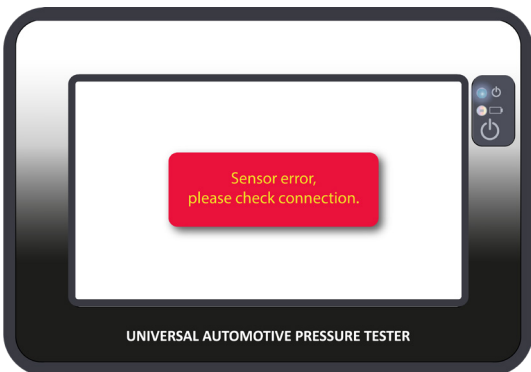
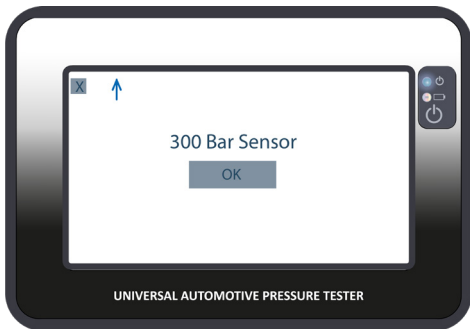
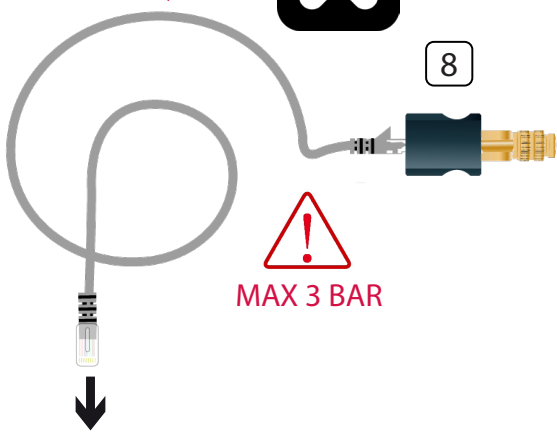
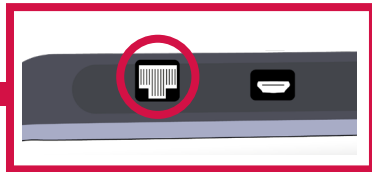
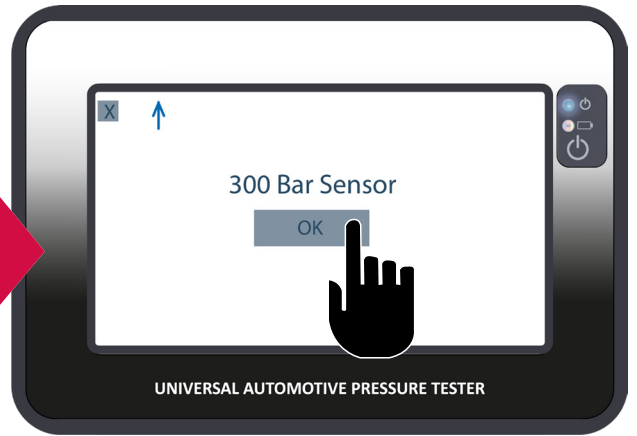
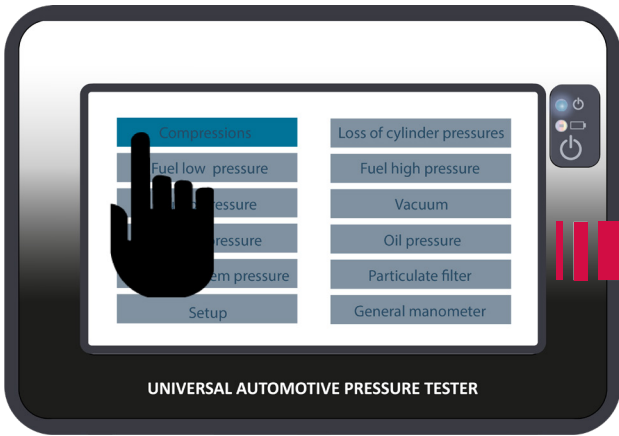



Compressions

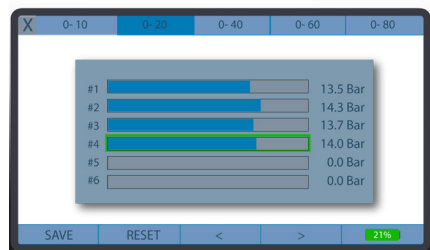
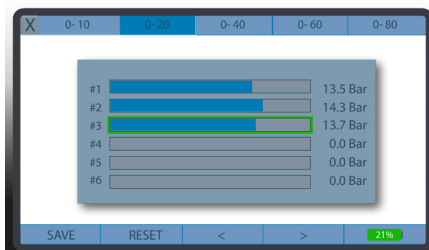
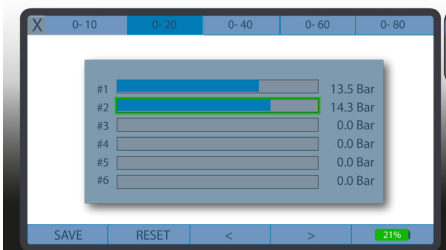
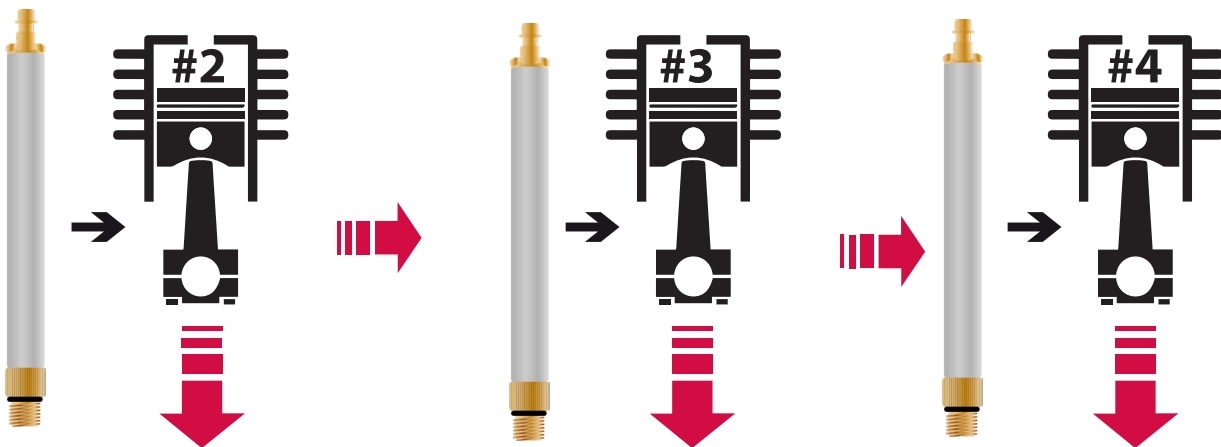
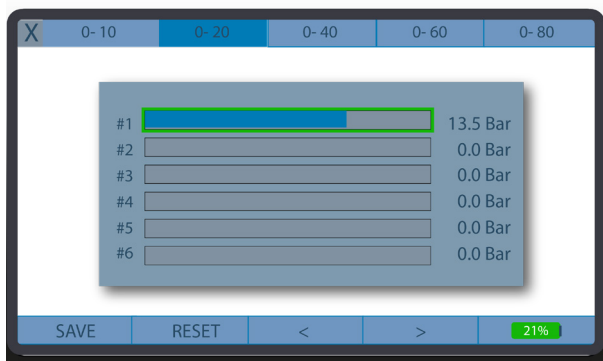
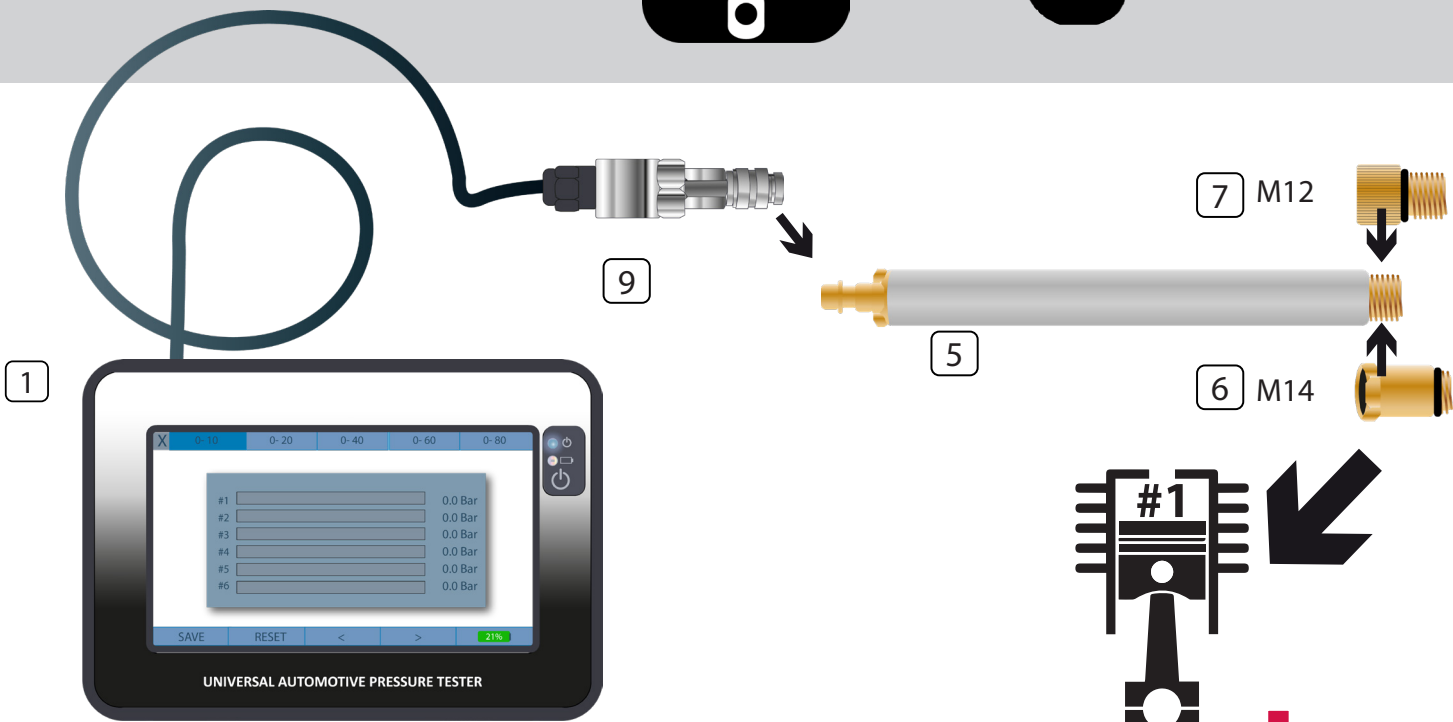



Compressions

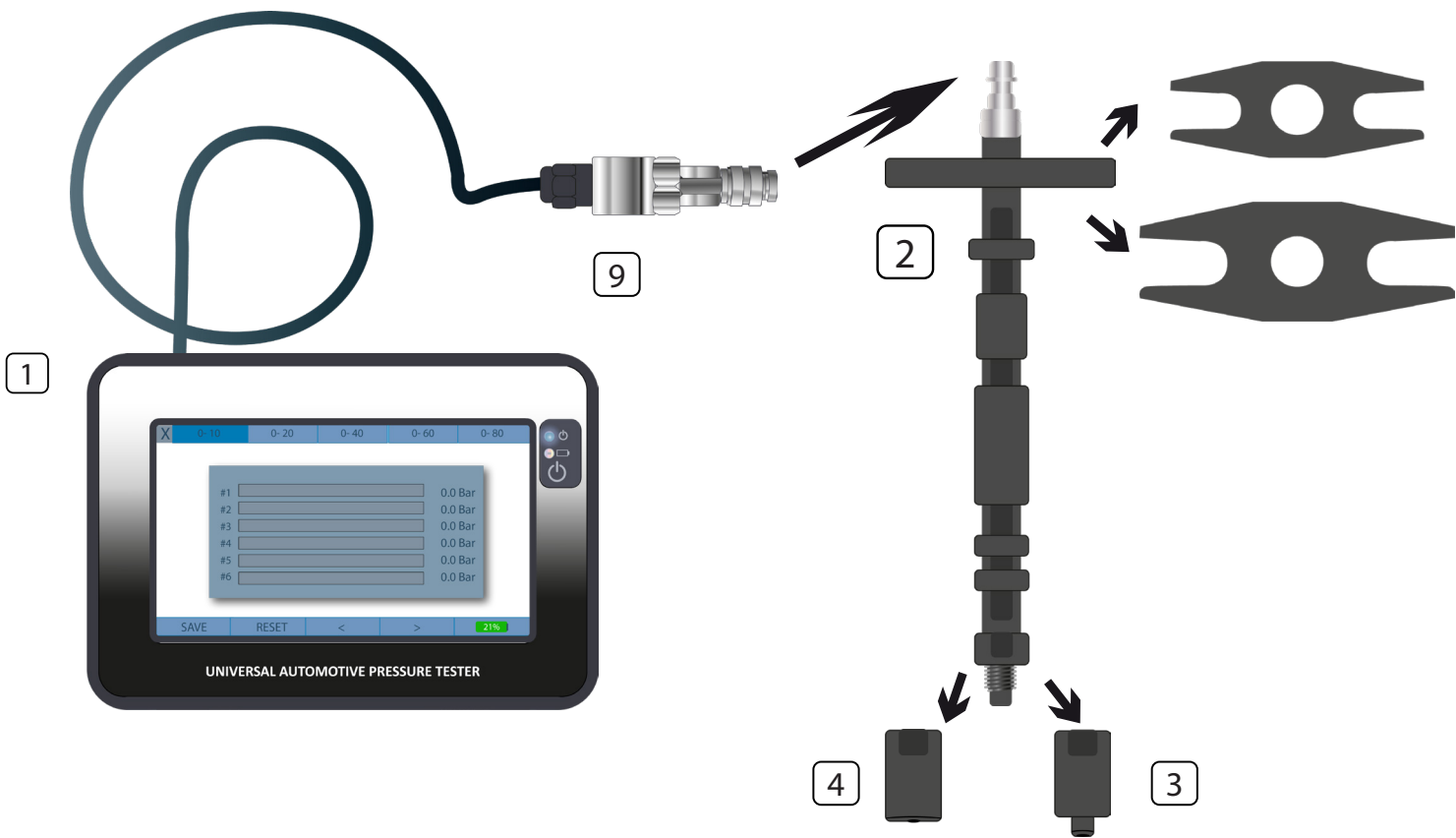
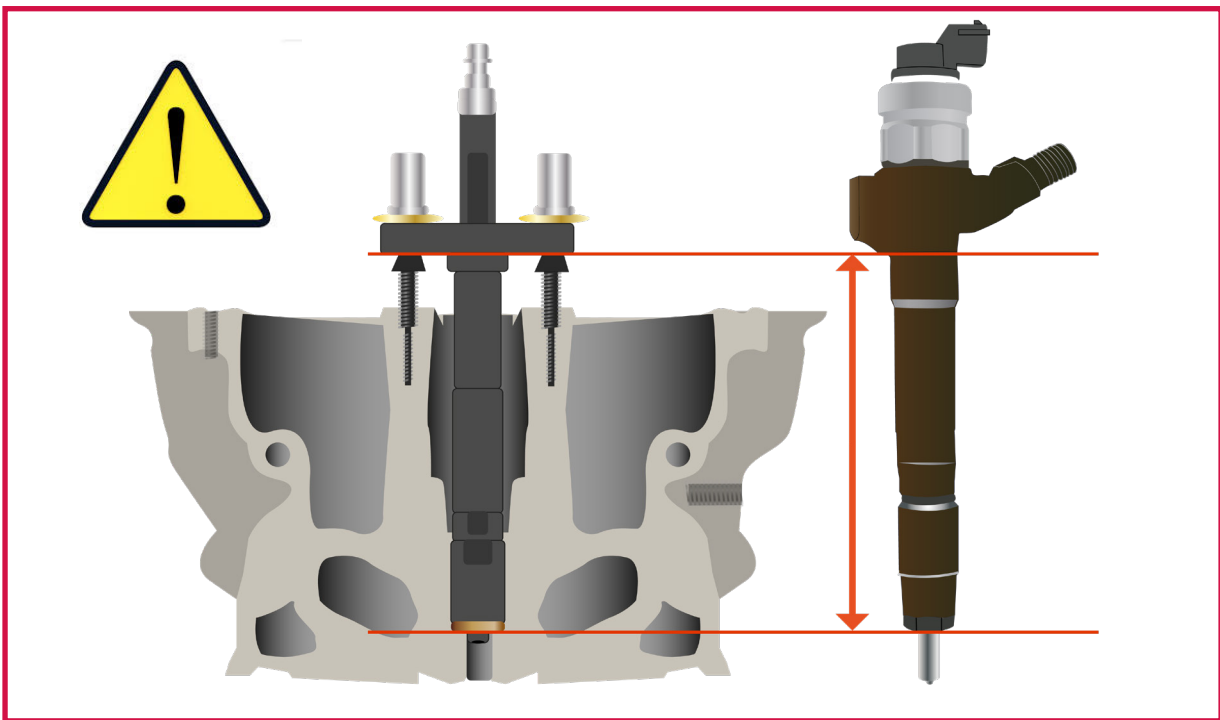

p4

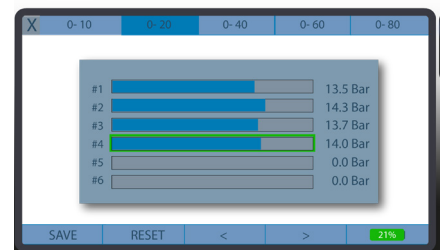
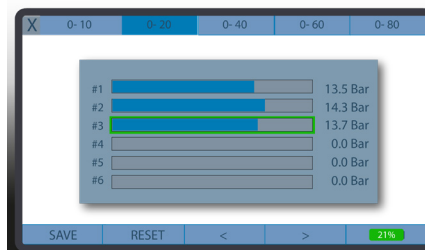
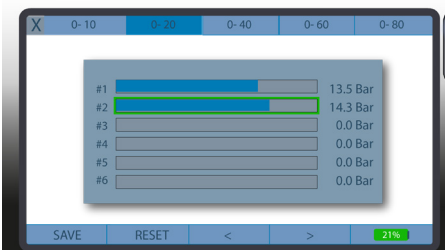
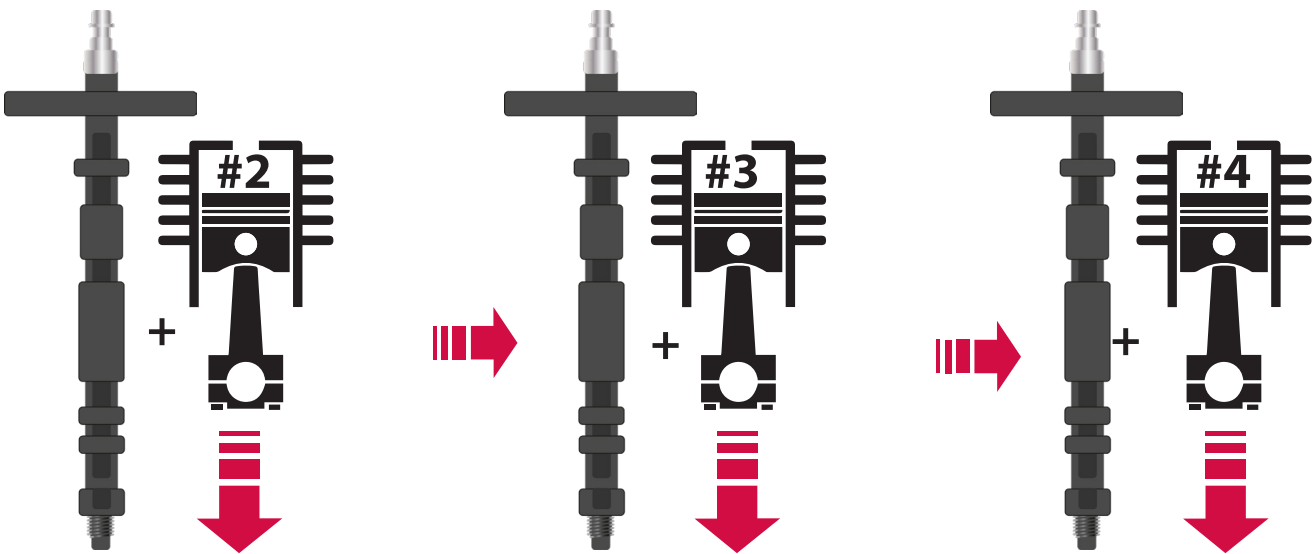
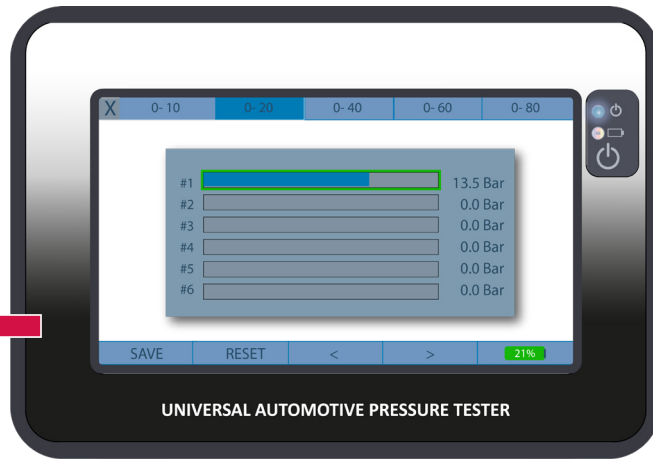
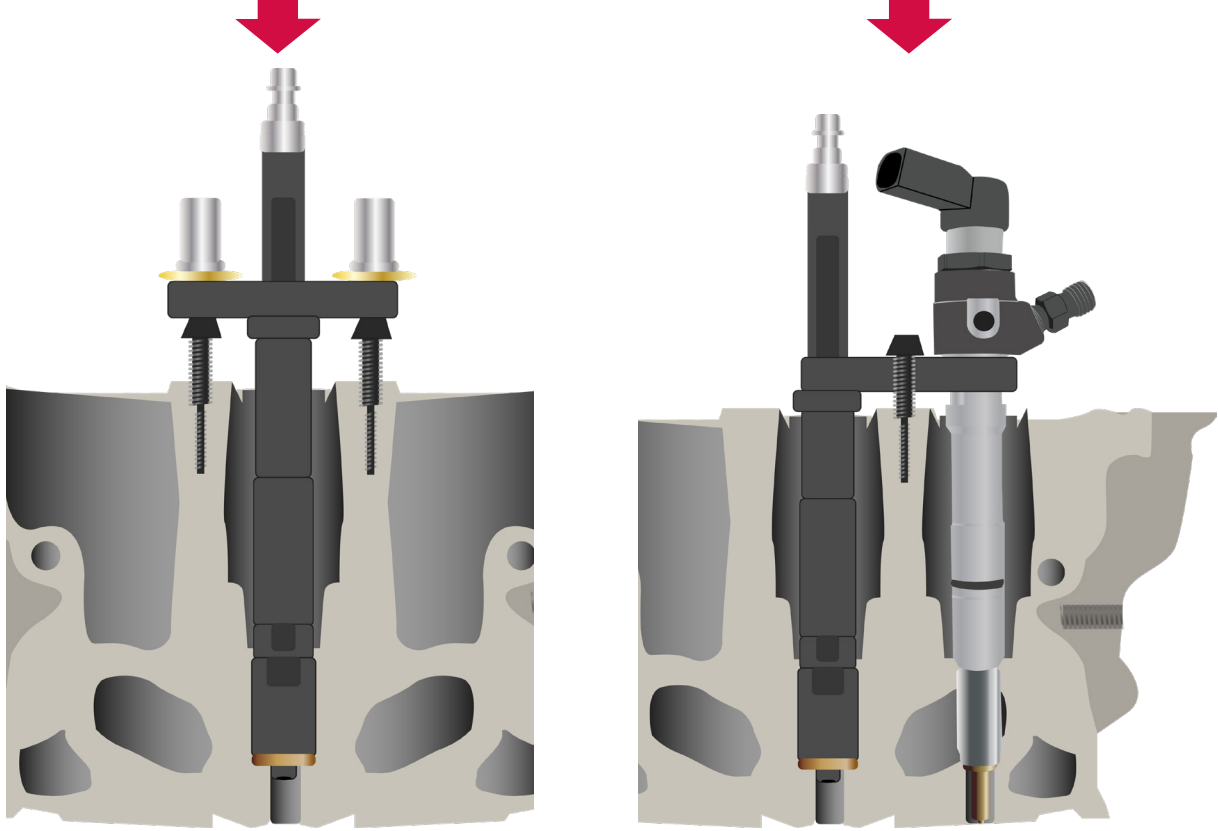

p5



Gasoline
Diesel

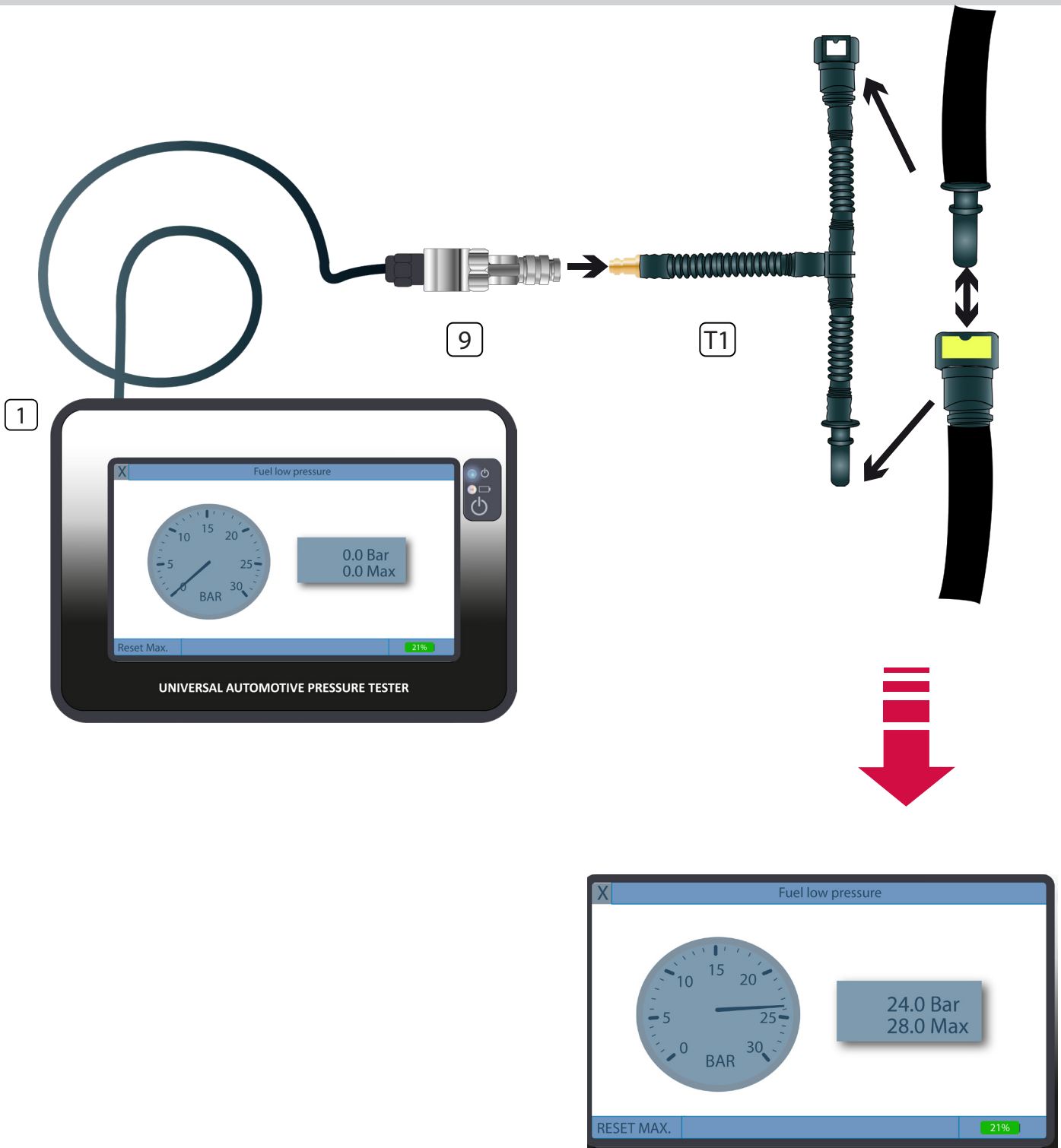

V



Turbo pressure

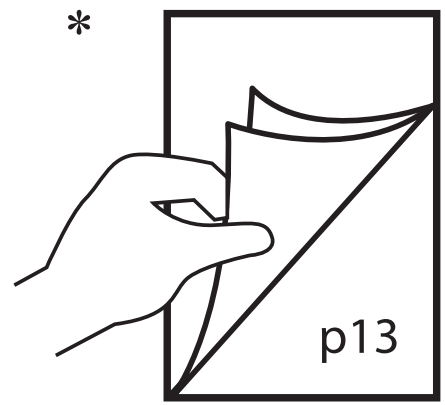
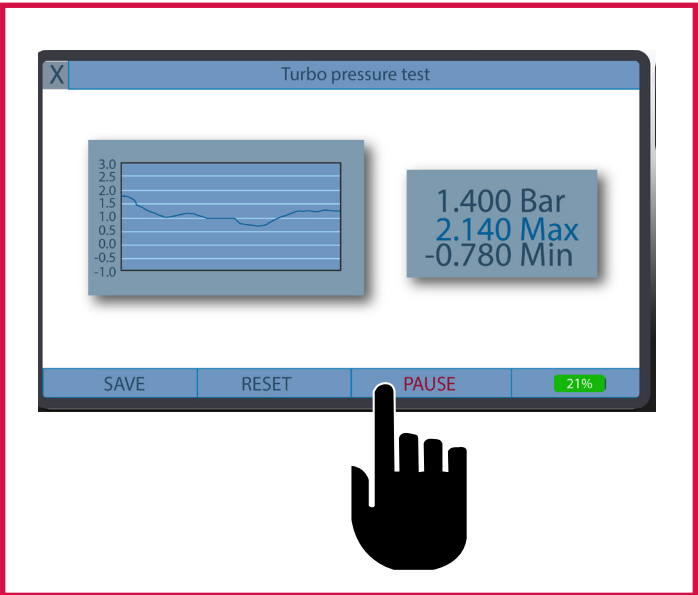
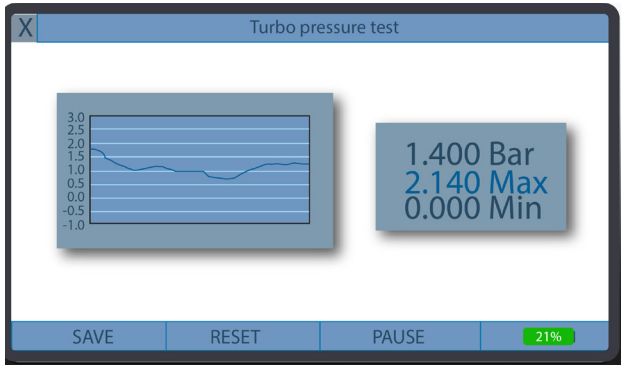
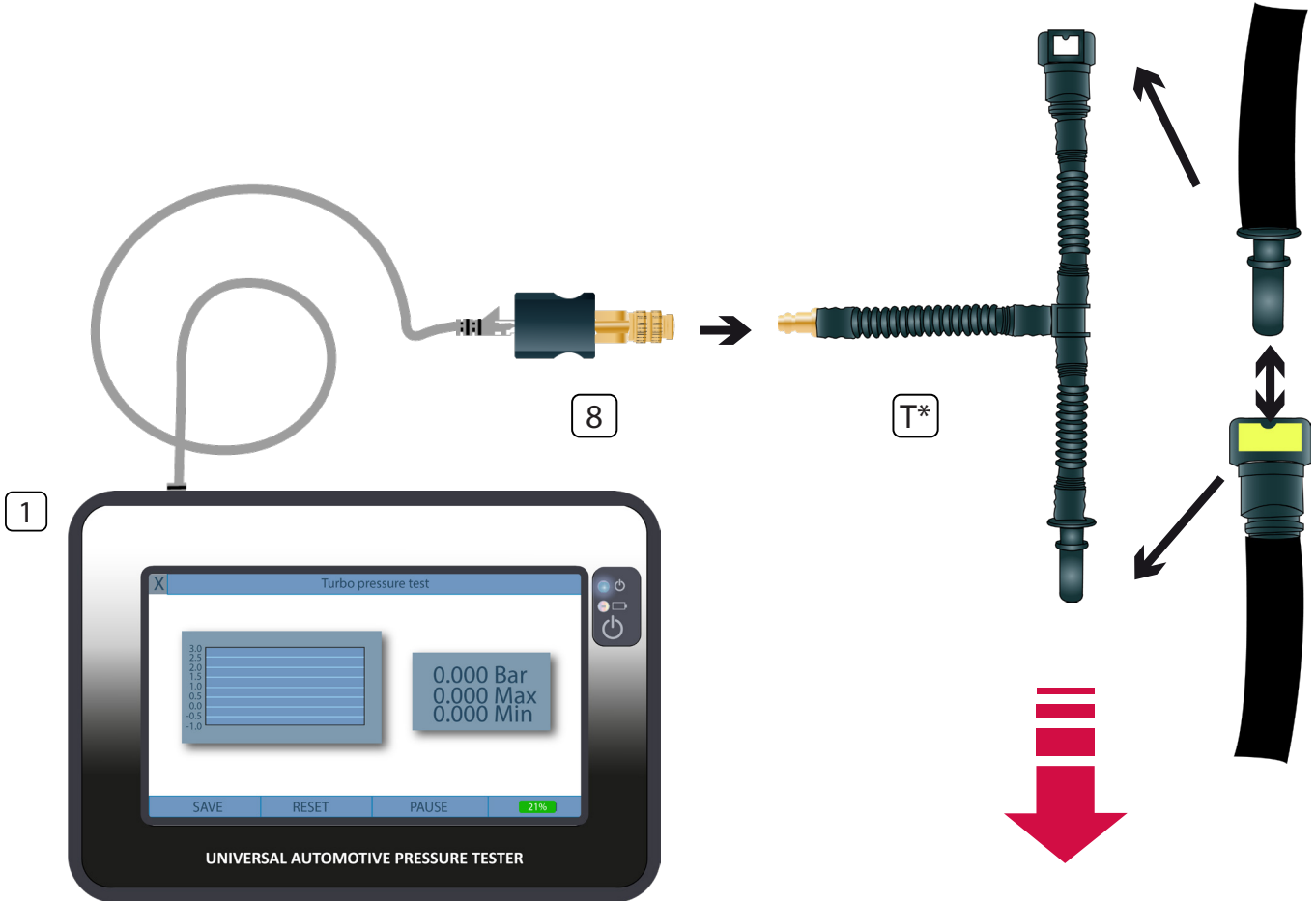



AD Blue pressure

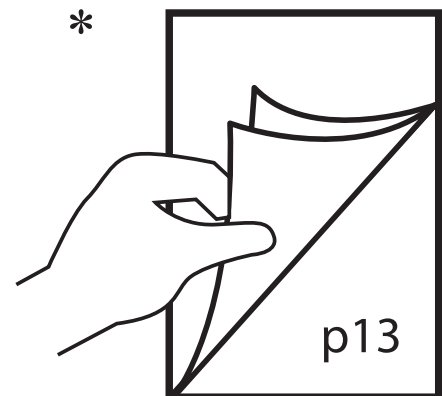
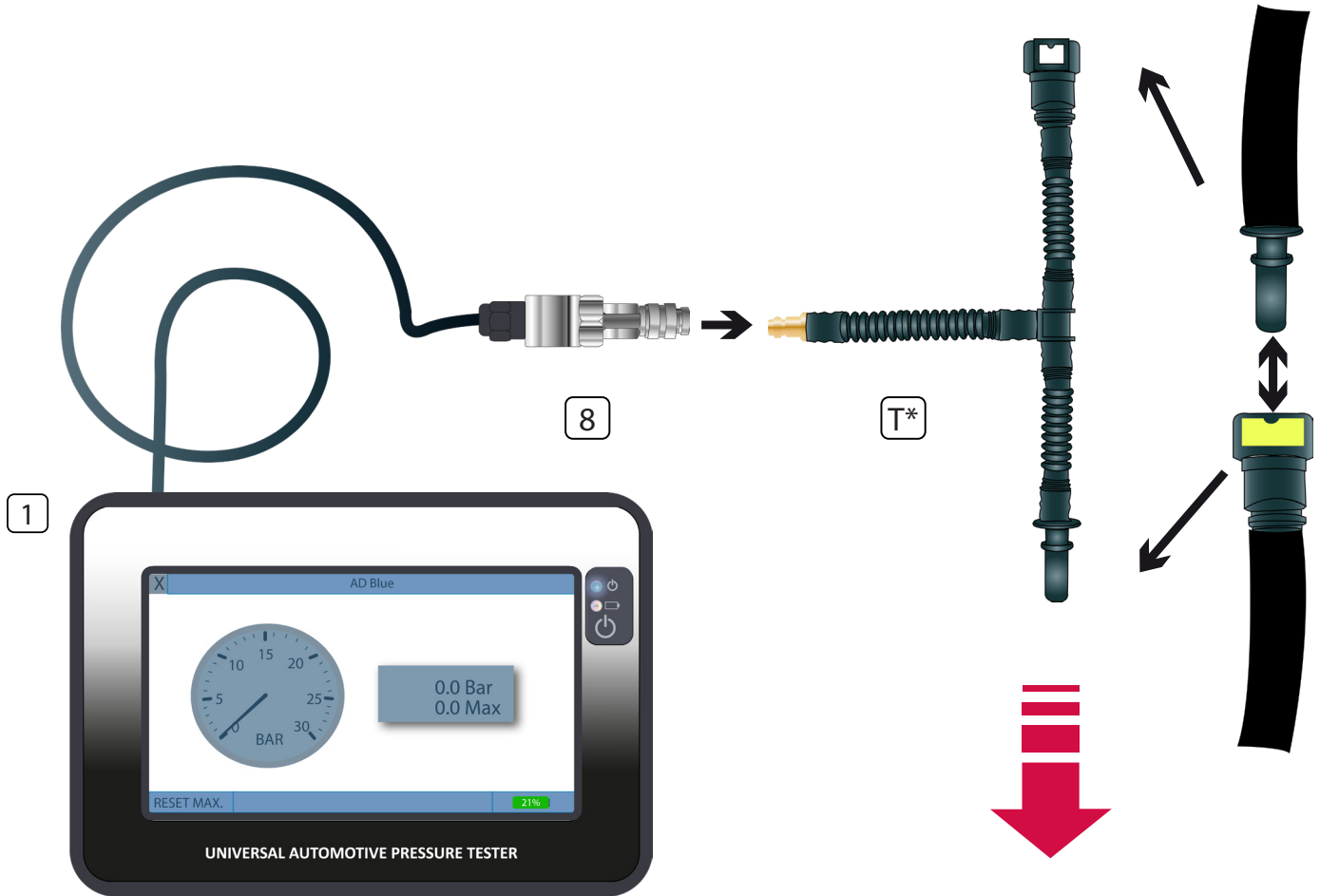



Cooling system pressure

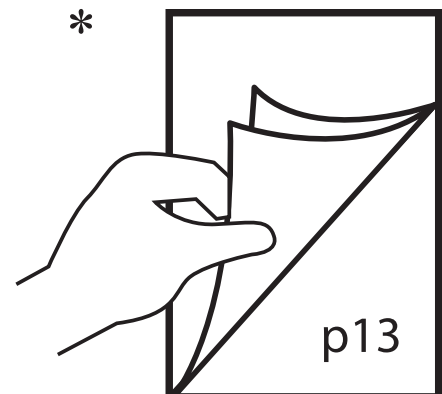
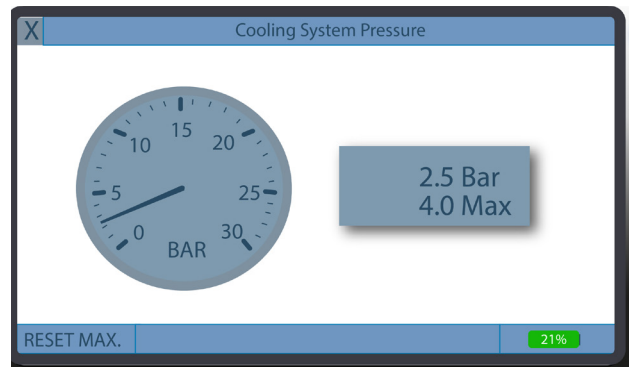
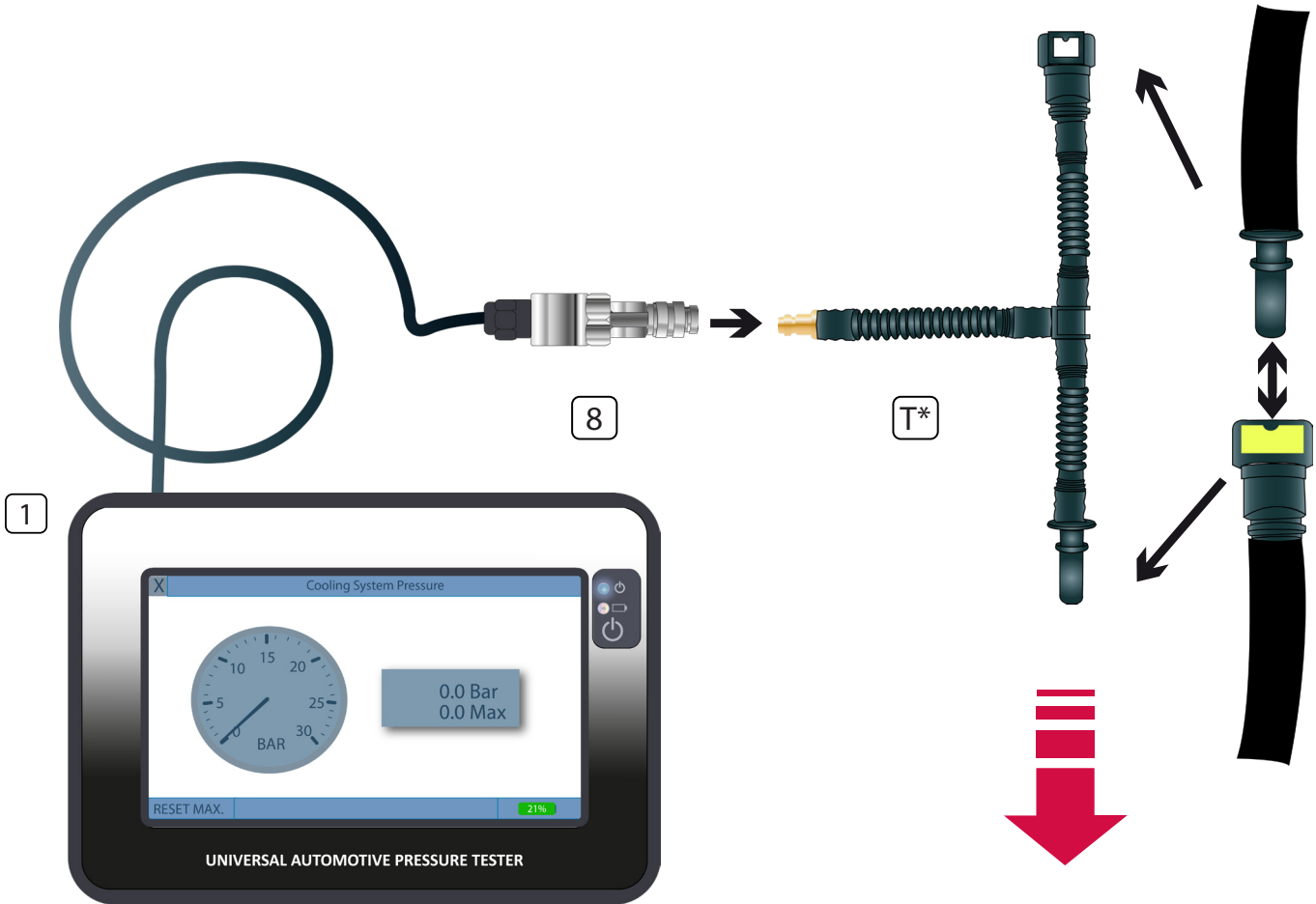

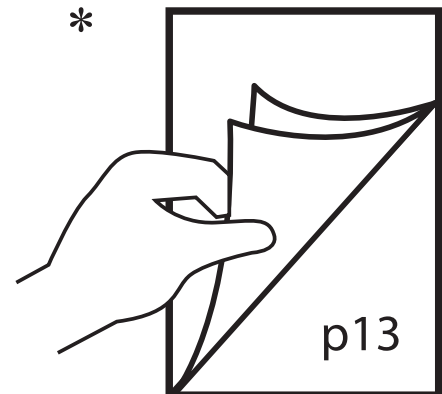
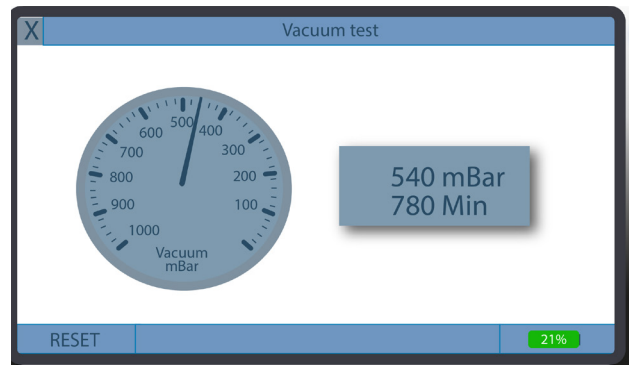
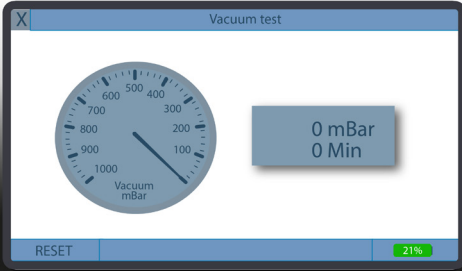
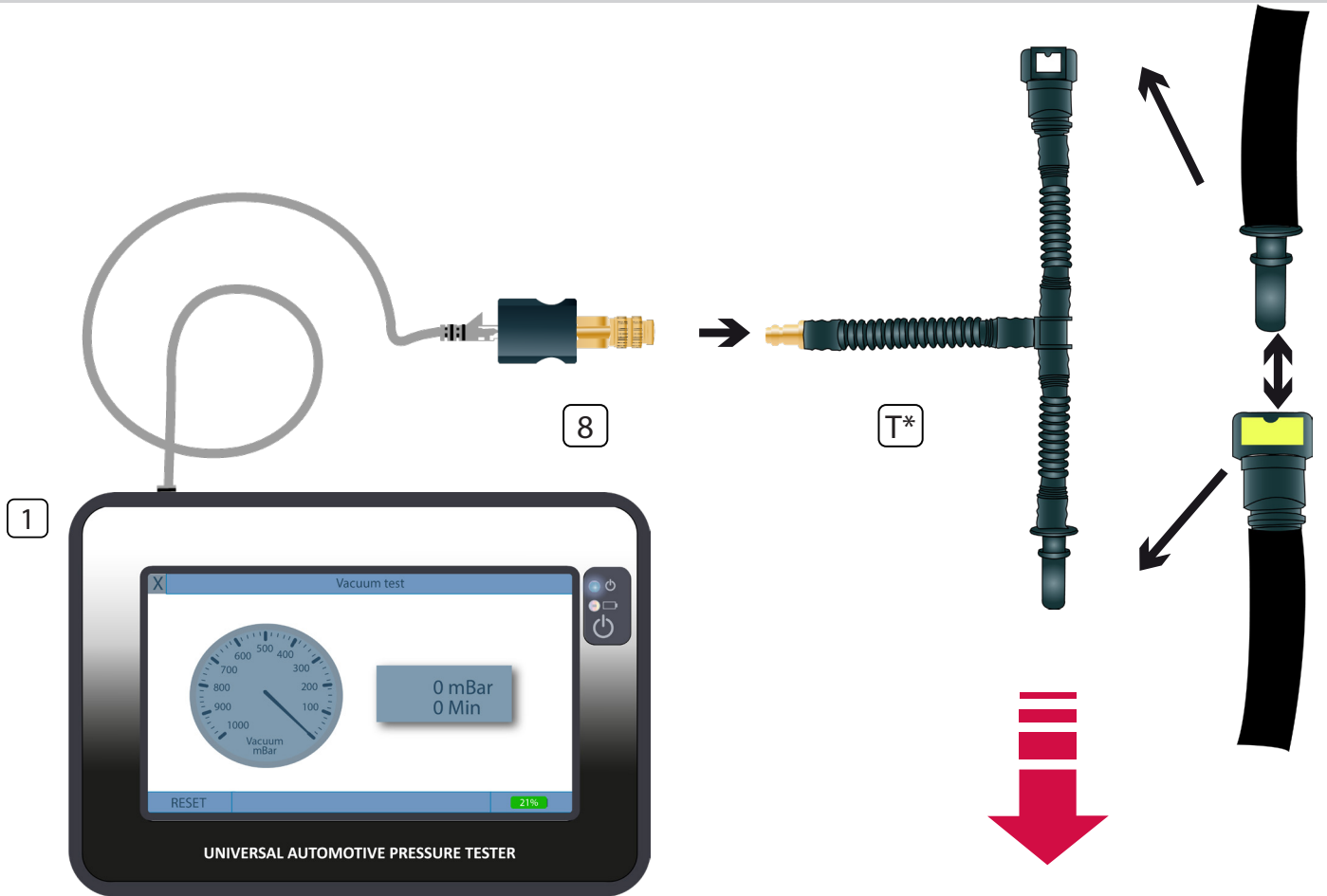



Oil pressure

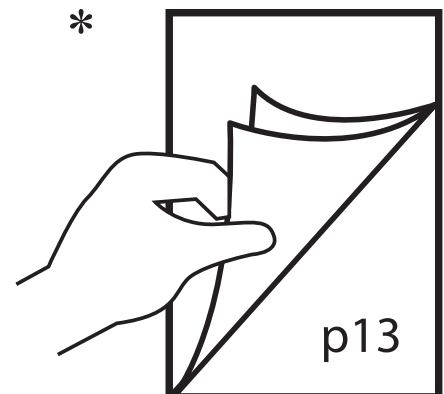
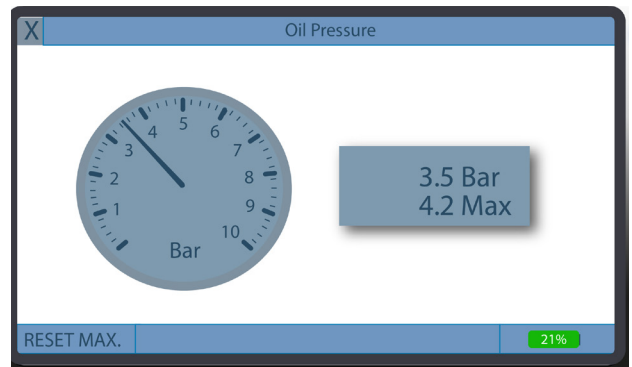
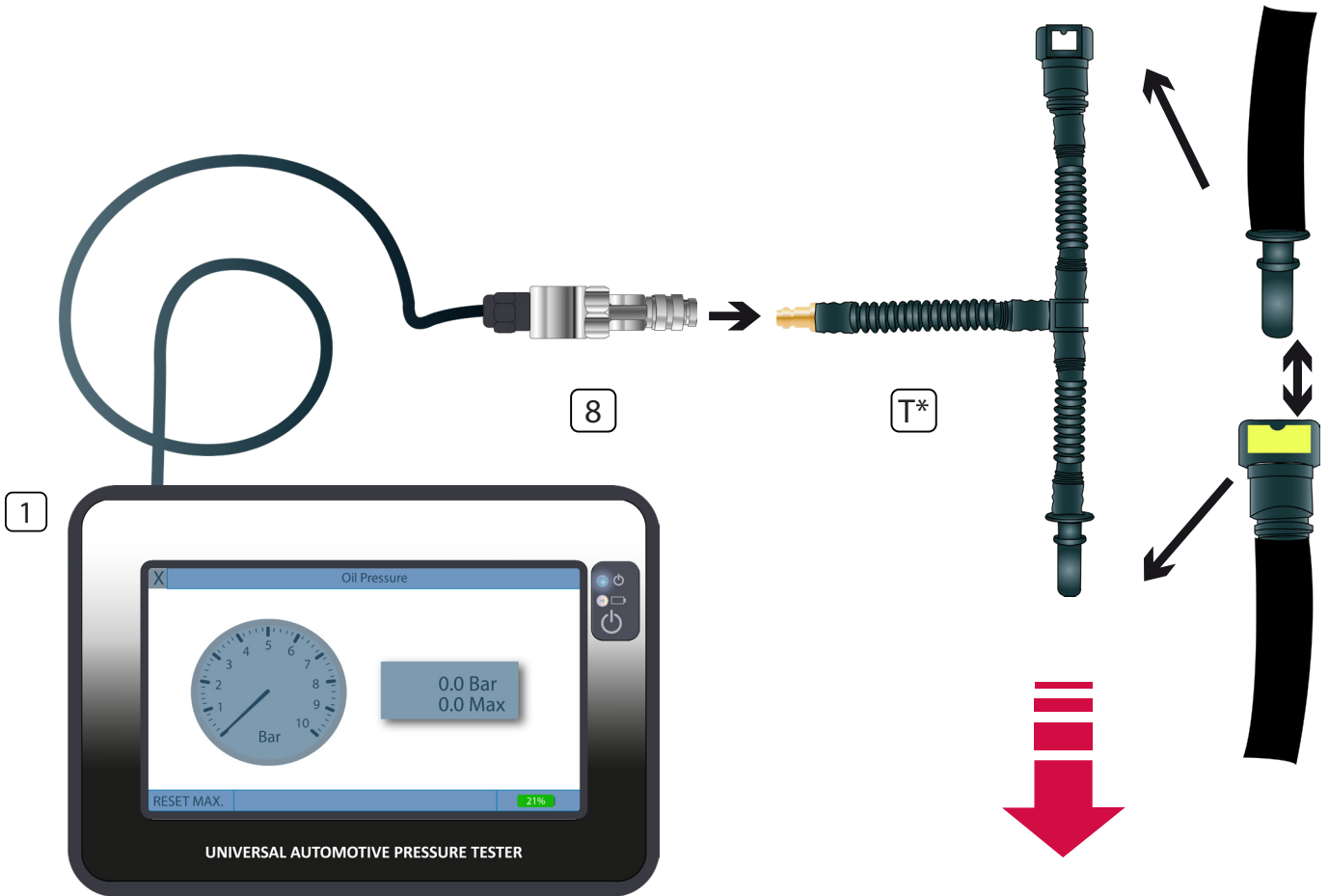

X



Particulate filter

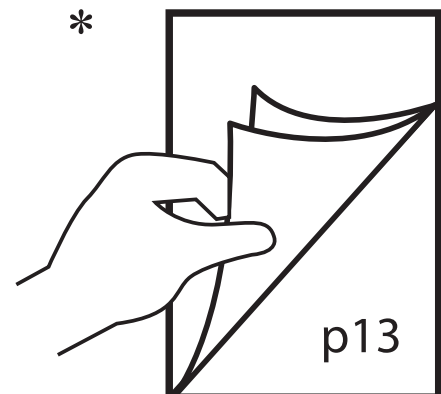
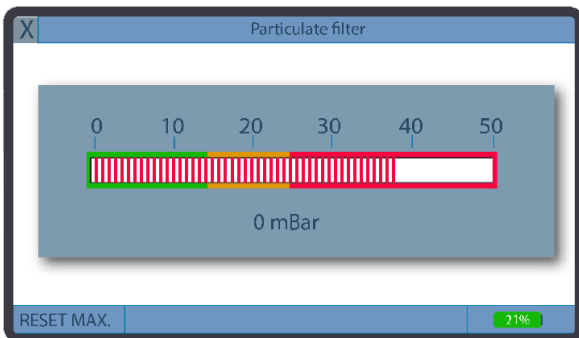
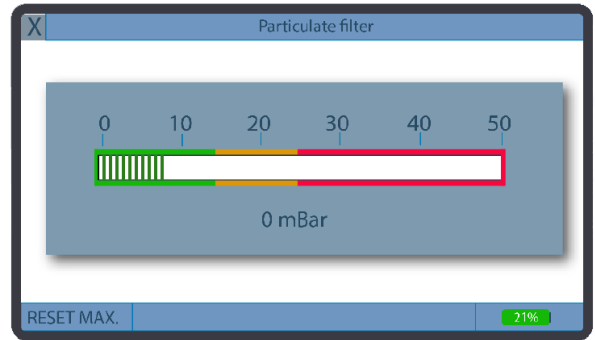
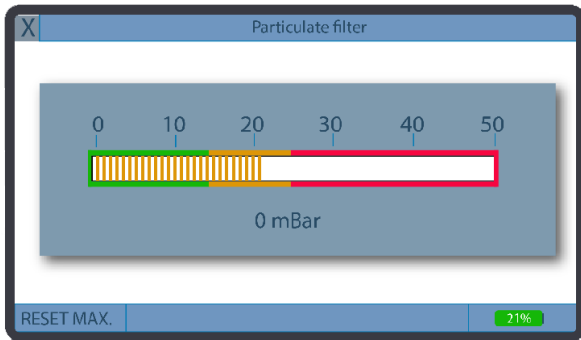
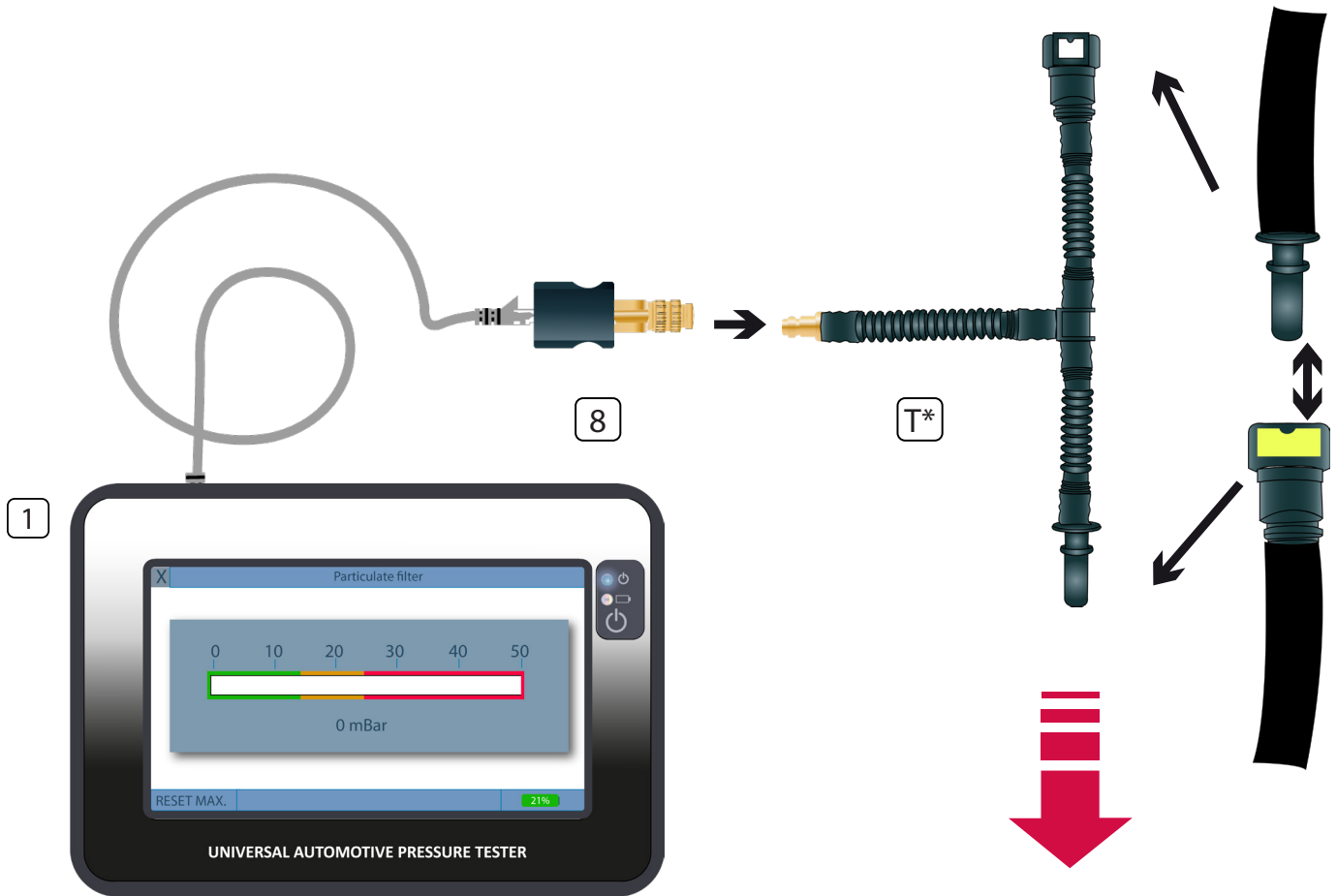



T1

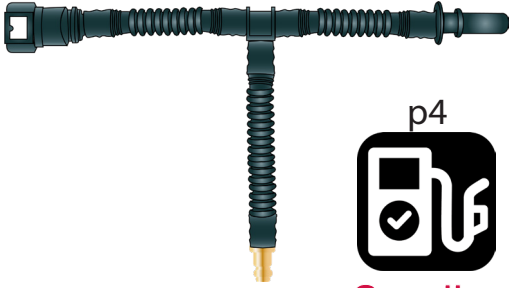

p4

Gasoline

p8

Diesel

T2

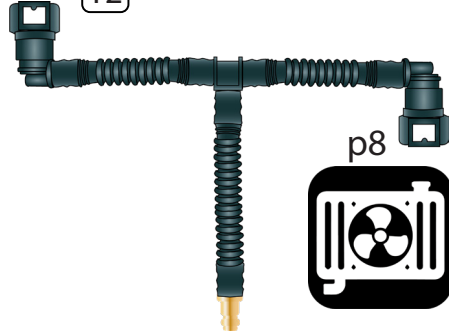

p8

p10

T3

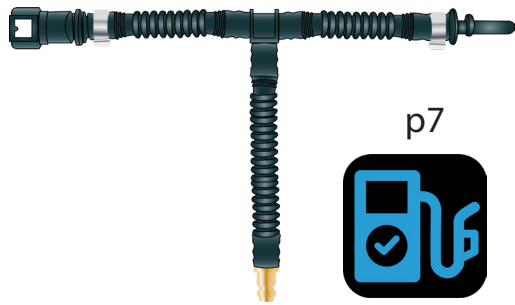

p7

T4



p6

p8

p9

p11

T5



p4

Gasoline

p6

Diesel

p8

p11

T6



p6

p9

p11

T7



p4

Gasoline

p8

T8



p4

Gasoline

p8

Diesel

p9

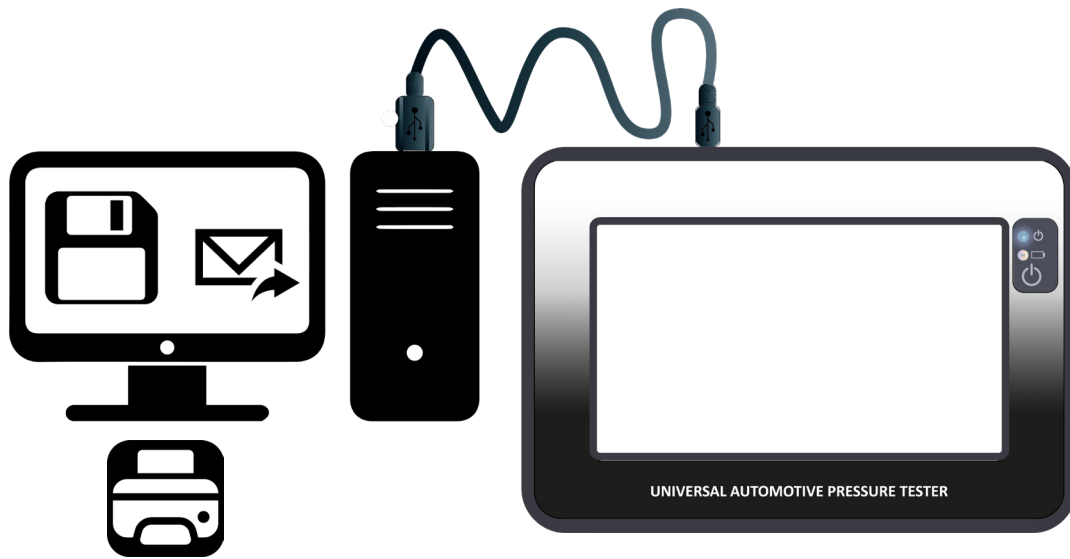
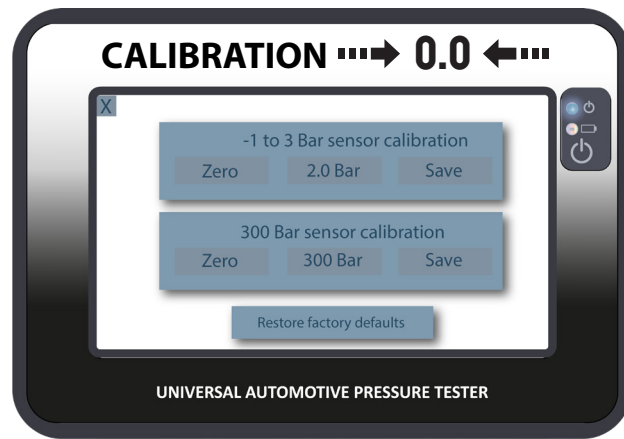

<http://universalpressuretester.com/software.exe>

BUSCHING

YouTube™

